

# Accuphase

*INTEGRATED STEREO AMPLIFIER*

## *E-407*

- Triple parallel push-pull output stage delivers quality power: 180 watts  $\times$  2 into 8 ohms
- Current feedback principle combines superb sound with total operation stability
- Logic-controlled relays for shortest signal paths
- Separator switch allows independent use of pre/power sections
- Large toroidal power transformer
- Balanced inputs
- Option board available for playback of analog records





**State-of-the-art integrated amplifier features current feedback topology for superb high-range phase fidelity. Wide-range power transistors in triple parallel push-pull configuration and massive toroidal transformer deliver ample power: 260 watts × 2 into 4 ohms, 180 watts × 2 into 8 ohms. Option board enables analog record reproduction in top-notch quality.**

The E-407 represents a new pinnacle of amplifier design. Featuring latest technology and using only the highest quality materials, this integrated stereo amplifier is destined to become a new reference. Frequency response, S/N ratio, and all other performance aspects make the E-407 perfectly suited for the new generation of ultra high quality program sources such as SACD and DVD-Audio.

An integrated amplifier provides various advantages such as convenient operation and modest space requirements. However, because its overall gain is very high, even the slightest interference or crosstalk at the input can have a considerable effect on the sonic result. To preclude this possibility, the E-407 is designed to achieve total electrical and structural separation of the preamplifier and power amplifier sections. These two parts operate as if they were entirely separate components. A switch even allows using the preamplifier and power amplifier independently. Accuphase's highly acclaimed current feedback topology virtually eliminates phase shifts in the upper frequency range and assures outstanding performance and sound quality. The power amplifier output stage employs a triple parallel push-pull configuration, using multi-emitter power transistors designed for high-power audio applications. Ample muscle is provided by the power supply section which features a massive, highly efficient toroidal power transformer housed in a diecast enclosure equipped with heat fins.

In the standard configuration, the E-407 has six inputs, two of which employ the balanced principle that assures ideal signal transmission characteristics. Provisions for two tape recorders, with easy dubbing in both directions, tone controls, and loudness compensation are further attractive features. An optional analog disc input board allows reproduction of analog records with outstanding sonic quality.

The external design of the E-407 continues the Accuphase tradition, featuring a champagne gold brushed front panel. Two large power meters in the center are flanked by the input selector section and the volume control. Not only by virtue of

its excellent sound, from its looks as well the E-407 is a great addition to any living room.

**Triple parallel push-pull output stage delivers quality power: 260 watts/channel into 4 ohms, 220 watts/channel into 6 ohms or 180 watts/channel into 8 ohms**

The output devices are multi-emitter power transistors designed for high-power audio applications. These devices have excellent frequency response, forward-current transfer ratio linearity, and switching performance characteristics. They are connected in a triple parallel configuration (Figure 1) for low impedance and mounted directly on a large heat sink to assure efficient dissipation of thermal energy. This allows the E-407 to deliver ample power output, amounting to 260 watts into 4 ohms, 220 watts into 6 ohms, or 180 watts into 8 ohms per channel.

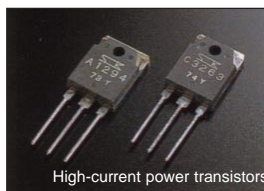

High-current power transistors

**Current feedback topology in power amplifier and preamplifier sections guarantees top-level performance**

In the E-407, the signal current rather than the voltage is used for feedback. Figure 2 shows the operating principle of this circuit. At the sensing point of the feedback loop, the impedance is kept low and current detection is performed. An impedance-converting amplifier then converts the current into a voltage to be used as the feedback signal. Since the impedance at the current feed-

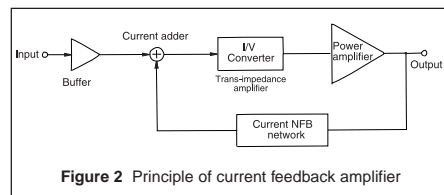

Figure 2 Principle of current feedback amplifier

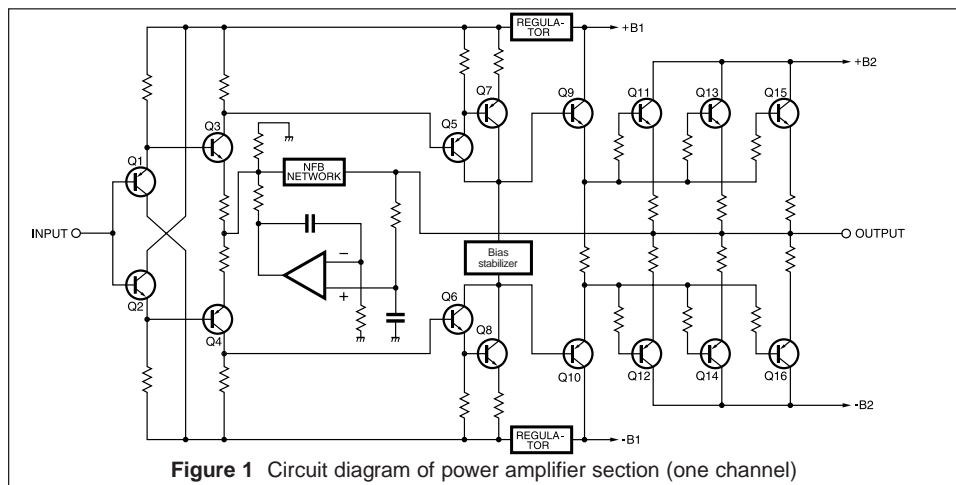

Figure 1 Circuit diagram of power amplifier section (one channel)

back point (current adder in Figure 2) is very low, there is almost no phase shift. Phase compensation can be kept to a minimum, resulting in excellent transient response and superb sonic transparency. Figure 3 shows frequency response for different gain settings of the current feedback amplifier. The graphs demonstrate that response remains uniform over a wide range.

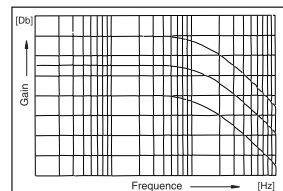
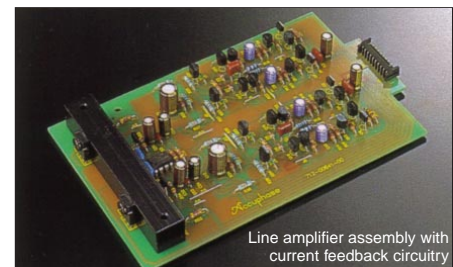

Figure 3 Frequency response with current feedback (Response remains uniform also when gain changes)

**Discrete-type line amplifier for superior sonic purity**

The line amplifier is entirely built from discrete parts, to assure optimum performance. Using a principle developed by Accuphase, a differential pure complementary push-pull circuit is combined with a single-ended push-pull emitter follower output stage. This comparatively simple topology reduces the need for phase compensation, resulting in effortless, utterly natural and transparent sound.



Line amplifier assembly with current feedback circuitry

**Highly reliable logic-controlled relays**

Program source switching is performed by logic-controlled relays which are arranged so as to permit the shortest possible signal paths. The hermetically sealed relays are high-quality types developed specifically for demanding communication applications. The contacts are twin crossbar types plated with gold for minimum contact resistance and outstanding long-term reliability.

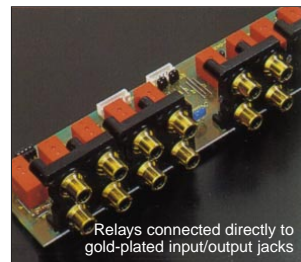

Relays connected directly to gold-plated input/output jacks

**Tone controls use summing active filters for pure sound**

The tone control circuitry in the E-407 was specially designed with summing active filters. Figure 4 illustrates the operation principle of this cir-





- Supplied remote commander RC-20  
Allows volume control and source switching

cuit. The flat signal is passed straight through, and only when an adjustment is required, the characteristics created at F1 and F2 are added to the signal, thereby producing the desired change. This design provides efficient control without degrading signal purity.

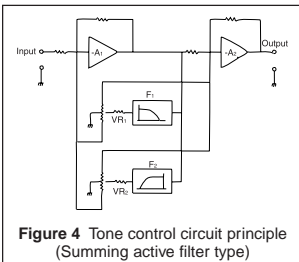

Figure 4 Tone control circuit principle (Summing active filter type)

### Large toroidal power transformer and high filtering capacity

The power supply section is a critical aspect of any power amplifier. The E-407 features a large toroidal power transformer with a rating of 600 VA. The transformer is housed in a non-resonant aluminum enclosure filled with damping material that has excellent heat transfer characteristics. Toroidal transformers which use heavy-gauge copper wiring on a ring-shaped core have various advantages, such as very low impedance, small size, and high conversion efficiency. The toroidal type transformer used by Accuphase is ideally suited for audio applications. It has the following characteristics:

- ① Near-circular core caliber allows near-circular coil windings with high packing density, resulting in low leakage flux and minimum vibrations.
- ② Smaller ferrite core diameter and copper windings with high specific gravity mean low

ferrite losses and low inrush current.



Massive filtering capacitors and large toroidal power transformer

Two massive electrolytic capacitors, each rated for 33,000 uF assure ample reserves also for reproduction of the most demanding passages.

### Dedicated headphone amplifier for best sound

The E-407 provides a separate amplifier for the phone jack designed to provide superior sonic performance. The speaker output can be cut off by a switch, and the main volume control can be used to adjust the headphone listening level.

### Two sets of heavy-duty speaker terminals

The oversize speaker terminals are made of extruded high-purity brass material which

accept also heavy-gauge speaker cable. Two sets of outputs with a speaker selector are provided, and bi-wiring (supplying the same signal via dual leads to speakers with separate high-frequency and low-frequency inputs) is also possible.



Heavy-duty speaker terminals

### Large analog peak power meters

The power meters use logarithmic compression to cover a wide dynamic range, letting you easily monitor the output level of the rapidly fluctuating music signal. Meter illumination can be switched off, which is convenient for example in a home theater setup.

Power amplifier assembly with triple parallel push-pull output devices mounted to large heat sink and current feedback amplifier circuitry

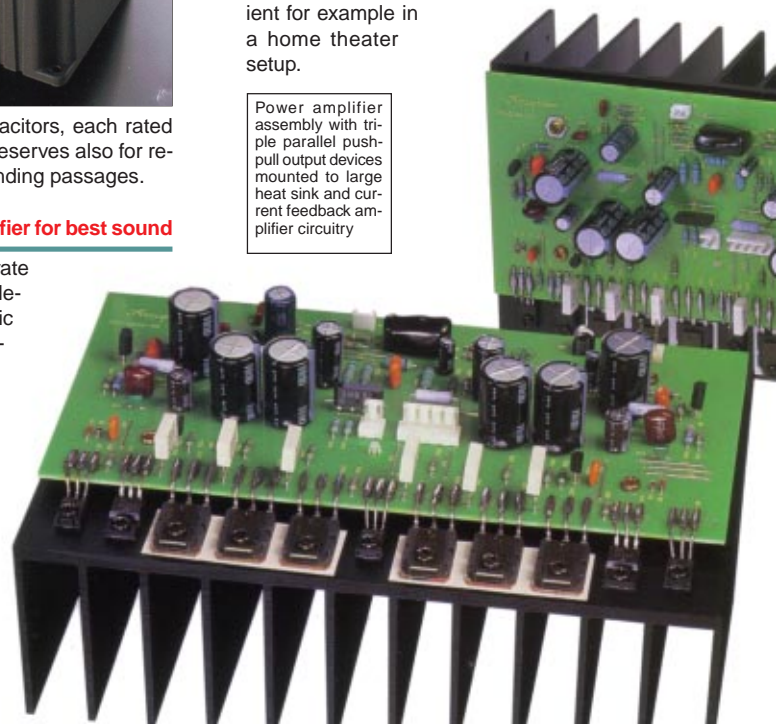

## Versatile input configuration including balanced connectors

The input selector of the E-407 controls a total of eight positions (including two option board positions) plus two tape recorders. Two of the standard inputs (CD and LINE) are designed for balanced connections which are not affected by externally induced noise, ensuring signal transmission with optimum sonic purity.

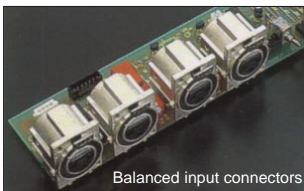

Balanced input connectors

## High-quality volume control, supplied remote commander allows source switching and volume adjustment

## Separator switch and set of inputs/outputs enable independent use of preamplifier and power amplifier sections

## Option Boards

The rear panel of the E-407 provides two slots in which an optional input board can be installed easily. Two types of boards, as shown below, are available.

- Analog Disc Input Board AD-9 and Line Input Board LINE-9 can also be used.
- Both boards use the AAB (Accuphase Analog Bus) interface.



### Line Inputs Board LINE-10

This option board provides an additional set of conventional line inputs which can be used to connect a CD player, tuner, or other component with analog output.

### Analog Disc Input Board AD-10

This board contains a high-performance, high gain phone equalizer. The board can be used with any type of phone cartridge.

Internal DIP switches control MM/MC operation, MC input impedance, and subsonic filter on/off.

<b>MM</b>	Gain	:	36 dB
	Input impedance	:	47 kohms
<b>MC</b>	Gain	:	62 dB
	Input impedance	:	10/30/100 ohms (selectable)

## FRONT PANEL

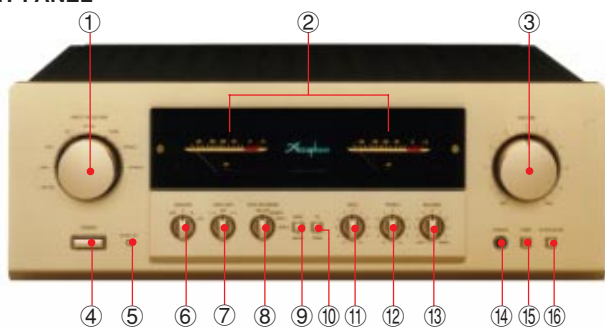

## REAR PANEL

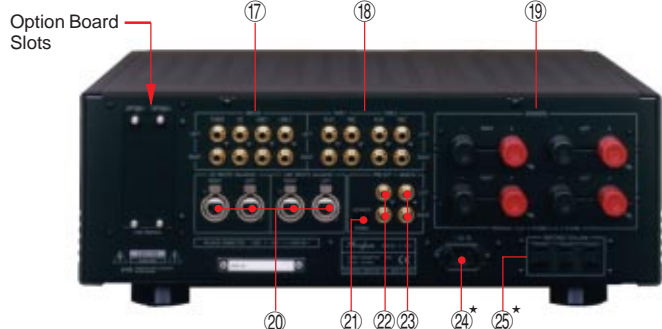

- |   |   |
|---|---|
| ① Input selector<br>LINE-BAL LINE-2 LINE-1 CD<br>CD-BAL TUNER OPTION-1 OPTION-2 | ⑫ Treble control                                |
| ② Left/right output meters (dB scale)   | ⑬ Balance control                               |
| ③ Volume control  | ⑭ Headphone jack                                |
| ④ Power switch  | ⑮ Loudness compensator switch                   |
| ⑤ Meter operation/illumination switch   | ⑯ Attenuator switch                             |
| ⑥ Speaker selector OFF A B A+B  | ⑰ Line inputs                                   |
| ⑦ Tape copy selector 1→2 OFF 2→1  | ⑱ Tape recorder inputs and outputs              |
| ⑧ Recording output/tape monitor selector<br>REC OFF SOURCE TAPE-1 TAPE-2        | ⑲ Left/right speaker output terminals           |
| ⑨ Mode switch   | ⑳ CD/LINE balanced inputs                       |
| ⑩ Tone control ON/OFF switch  | ㉑ Preamplifier/power amplifier separator switch |
| ⑪ Bass control  | ㉒ Preamplifier outputs                          |
|   | ㉓ Power amplifier inputs                        |
|   | ㉔ AC inlet (for supplied power cord)*           |
|   | ㉕ Switched AC outlets*                          |

### Remarks

- \* This product is available in versions for 120/230 V AC. Make sure that the voltage shown on the rear panel matches the AC line voltage in your area.
- \* The 230 V AC model does not have the SWITCHED power outlet.
- \* The shape of the AC inlet, plug of the supplied power cord, and AC outlet depends on the voltage rating and destination country.
- \* These switched AC outlets may not be supplied depending on the safety standards or regulations applicable in the particular country to where the unit is destined.

Supplied accessories: • AC power cord  
• Remote commander RC-20

## GUARANTEED SPECIFICATIONS

[Guaranteed specifications are measured according to EIA standard RS-490.]

- **Continuous Average Output Power** (both channels driven, 20 - 20,000 Hz)  
260 watts per channel into 4 ohms  
220 watts per channel into 6 ohms  
180 watts per channel into 8 ohms
- **Total Harmonic Distortion** (both channels driven, 20 - 20,000 Hz)  
0.02%, with 4 to 16 ohms load
- **Intermodulation Distortion**  
0.01%
- **Frequency Response**  
HIGH LEVEL INPUT/MAIN INPUT  
20 - 20,000 Hz +0, -0.2 dB (for rated output)  
2 - 150,000 Hz +0, -3.0 dB (for 1 watt output)
- **Damping Factor**  
120 (with 8-ohm load, 50 Hz)
- **Input Sensitivity, Input Impedance**

Input	Sensitivity		Input impedance
	For rated output	For 1 W output (EIA)	
HIGH LEVEL INPUT	158 mV	11.2 mV	20 kW
BALANCED INPUT	158 mV	11.2 mV	40 kW
MAIN INPUT	1.58 V	112 mV	20 kW

- **Output Voltage, Output Impedance** PRE OUTPUT: 1.58 V, 50 ohms  
(at rated continuous average output)
- **Gain**  
MAIN INPUT → OUTPUT: 28 dB  
HIGH LEVEL INPUT → PRE OUTPUT: 20 dB
- **Tone Controls**  
Turnover frequency and adjustment range  
BASS: 300 Hz ±10 dB (50 Hz)  
TREBLE: 3 kHz ±10 dB (20 kHz)
- **Loudness Compensation**  
+6 dB (100 Hz), (Volume control setting -30 dB)
- **Signal-to-Noise Ratio** (input-converted noise)

Input	Input shorted, IHF-A weighting S/N ratio at rated input	S/N ratio (EIA)
HIGH LEVEL INPUT	113 dB	82 dB
BALANCED INPUT	92 dB	82 dB
MAIN INPUT	128 dB	103 dB

- **Power Level Meters**  
S/N ratio (EIA) Logarithmic compression, peak reading meters  
dB scale
- **Load Impedance**  
4 - 16 ohms
- **Stereo Headphones**  
Suitable impedance: 4 - 100 ohms
- **Power Requirements**  
120 V / 230 V (voltage indicated on rear panel)  
AC, 50/60 Hz
- **Power Consumption**  
55 watts idle  
410 watts in accordance with IEC-65
- **Maximum Dimensions**  
Width 475 mm (19-11/16")  
Height 180 mm (7-1/16")  
Depth 423 mm (16-5/8")
- **Weight**  
23.7 kg (52.2 lbs) net  
28.0 kg (61.7 lbs) in shipping carton
- **Supplied Remote Commander RC-20**  
Remote control principle: Infrared pulse  
Power supply: 3 V DC (IEC R6 batteries x 2)  
Dimensions: 55 (width) x 194 (height) x 18 (depth) mm  
Weight: 100 g (including batteries)